

Hydra Super-S LCM

4-Bay RAID Storage Enclosure (3.5" SATA HDD)



User Manual

July 30, 2009 - v1.2



EN

1 Introduction

1.1 System Requirements

1.1.1 PC Requirements

- Minimum Intel Pentium III CPU 500MHz, 128MB RAM
- eSATA equipped PC; Windows XP/Vista
- FireWire equipped PC; Windows XP/Vista
- USB 2.0 (USB 1.1) equipped PC; Windows XP/Vista
- Your hardware device must have the correct corresponding port (e.g. USB 2.0 host controller)
- Plug & Play support for eSATA host controller

1.1.2 Mac Requirements

- Minimum Apple G4 processor, 128MB RAM
- eSATA equipped Mac; Mac OS 10.4 or above
- FireWire equipped Mac; Mac OS 10.2 or above
- USB 2.0 (USB 1.1) equipped Mac; Mac OS 10.2 or above
- Your hardware device must have the correct corresponding port (e.g. USB 2.0 host controller)
- Plug & Play support for eSATA host controller

1.1.3 Supported Hard Drives

- Two to four 3.5" SATA-I or SATA-II hard drives (1.5Gb/s or 3.0Gb/s)
- Hard drives of identical capacities are recommended
- Supports large volumes in excess of 2TB

Note

In order for the computer to access volumes larger than 2TB, both the hardware and Operating System need to support large volumes (e.g.: WinVista 32bit/64bit or Mac OS 10.4 and above).

1.2 Package Contents

Package content may vary depending on vendor & version.

- Hydra Super-S LCM (hard drives not included)
- Power cord
- Interface cables
- User manual

1.3 About this Manual

Firmware, images and descriptions may slightly vary between this manual and the actual product you have. Functions and features may change depending on the firmware version. Please read your warranty carefully, as this may vary between different vendors!

1.4 Trademarks

- MS-DOS, Microsoft and Windows XP/Vista are trademarks of Microsoft Corporation.
- Apple Macintosh and Mac are trademarks of Apple Computer.
- All other third party brands and names are the property of their respective owners.

1.5 Detailed View

1.5.1 Front View

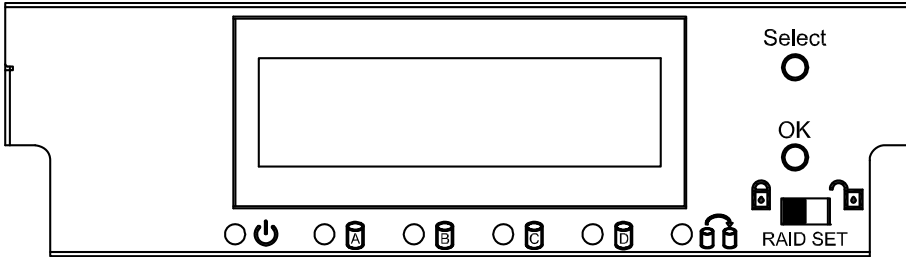

| LED/Button | Status |
|------------|--|
| | <ul style="list-style-type: none"> Blue = Power on |
| | <ul style="list-style-type: none"> Flashing green = Accessing data Flashing red = System starting up Steady red = Error or drive is not installed |
| | <ul style="list-style-type: none"> Flashing yellow = Rebuilding RAID array Steady yellow = One or more faulty drive(s) |
| | <ul style="list-style-type: none"> RAID mode can be changed via LCD display |
| | <ul style="list-style-type: none"> RAID mode locked |
| Select | <ul style="list-style-type: none"> Select setup menu or mode |
| OK | <ul style="list-style-type: none"> Confirm current option or enter setup menu |



When only 2 or 3 hard drives are installed, the red LED indication for the missing hard drives can be safely ignored.



Changing the RAID mode requires you to re-format the drives. This will erase all data on the hard drives that are being formatted. Make sure to backup all existing data first!

Note

In order to prevent an accidental change of the RAID mode, it can be locked. When the RAID mode is locked, it is not possible to change or access the RAID settings via LCD display. Instead, the display will show a message saying “RAID Mode Locked”.

1.5.2 Rear View

| Label | Description |
|--------------|---------------------------|
| | Security lock slot |
| ON/OFF | Power switch |
| AC: 100~240V | Power receptacle |
| eSATA | External SATA port |
| FW400 | FireWire 400 (1394a) port |
| FW800 | FireWire 800 (1394b) port |
| USB 2.0 | USB 2.0 High Speed port |

1.6 RAID Mode

Hard drives of identical capacities are recommended. If the capacities are different, the total amount of the space that can be used will depend on the drive with the smallest capacity. The difference in performance is only visible for fast interfaces like eSATA.

Note

Changing the RAID mode requires you to re-format the drives. This will erase all data on the hard drives that are being formatted. Make sure to backup all existing data first!

1.6.1 Disk Spanning

The drives show up as one large single volume but the total size will depend on the drive with the smallest capacity. Spanning is an array (not RAID) that is written sequentially across the drives. By itself, it does not provide any performance or redundancy benefits.

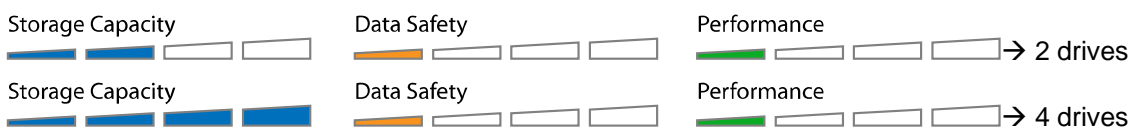

1.6.2 Disk Striping (RAID 0)

The drives show up as one large single volume but the total size will depend on the drive with the smallest capacity. Used where speed is the primary objective but RAID Level 0 (also called striping) is not redundant. This form of array splits each piece of data across the drives in segments. Since data is written without parity data-checking, it allows for the fastest data transfer but if one drive fails, the whole array can become corrupted.

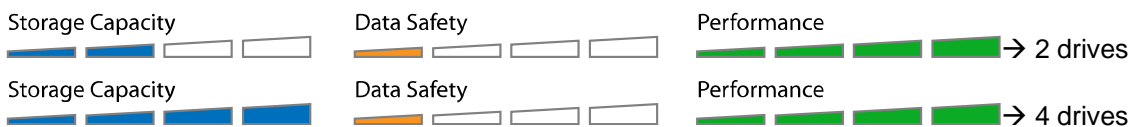

1.6.3 Disk Mirroring (RAID 1)

The drives show up as one volume but only 50% of the total capacity, depending on the drive with the smallest capacity, can be used. RAID 1 creates an exact copy (or mirror) of a set of data on the second drive. This is useful when reliability and backup are more important than capacity. When one drive fails, it can be replaced and the data rebuilt.



1.6.4 Disk Mirroring with Striping (RAID 10)

The drives show up as one volume but only 50% of the total capacity, depending on the drive with the smallest capacity, can be used. RAID 10 creates an exact copy (or mirror) of a set of data. This is useful when reliability and backup are more important than data capacity. When one hard drive fails, it can be replaced and the data rebuilt automatically.



1.6.5 Disk Striping with dedicated parity (RAID 3)

The drives show up as one volume but the total capacity, depending on the drive with the smallest capacity, is the combined size minus the size of one drive. RAID 3 uses byte-level striping with parity data stored on a dedicated disk. The single parity disk is a bottle-neck for writing since every write requires updating the parity data. One minor benefit is the dedicated parity disk allows the parity drive to fail and operation will continue without parity or performance penalty. When one hard drive fails, it can be replaced and the data rebuilt automatically.

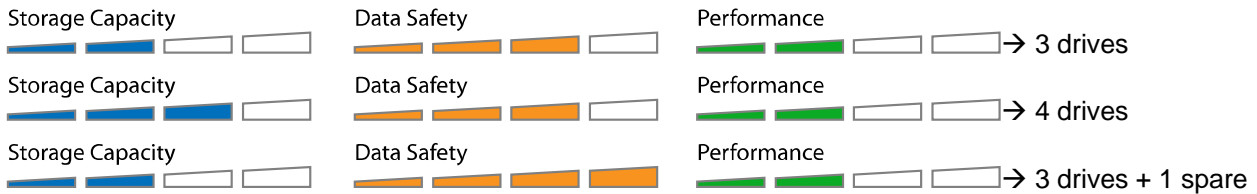

Spare Drive

When 3 hard drives plus 1 spare drive are used, the total capacity will only be as large as two drives. When one drive fails, the data will be rebuilt immediately by using the spare drive, rather than waiting for someone to replace the faulty one. To use a spare drive, install 3 drives, turn on the device, set it to RAID 3, let it restart and then install the fourth drive.

1.6.6 Disk Striping with distributed parity (RAID 5)

The drives show up as one volume but the total capacity, depending on the drive with the smallest capacity, is the combined size minus the size of one drive. RAID 5 uses block-level striping with parity data distributed across all member disks and therefore provides the perfect balance between high performance and data integrity. When one hard drive fails, it can be replaced and the data rebuilt automatically.

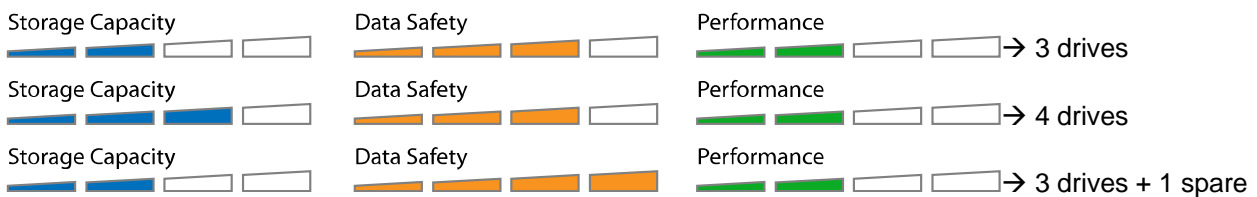

Spare Drive

When 3 hard drives plus 1 spare drive are used, the total capacity will only be as large as two drives. When one drive fails, the data will be rebuilt immediately by using the spare drive, rather than waiting for someone to replace the faulty one. To use a spare drive, install 3 drives, turn on the device, set it to RAID 5, let it restart and then install the fourth drive.

Note

It is not possible to add more drives to an existing RAID array without re-formatting it. To add additional drives at a later point, install the drive(s), change the RAID mode or re-confirm the current mode and then create a new partition and format the drives again.

1.7 About Data Backup

To protect your files and help prevent the loss of your data, we strongly recommend that you keep two copies of your data, one copy on your Hydra and a second copy either on your internal drive or another storage media such as CD, DVD, Tape or an additional external drive.

Any loss or corruption of data while using the Hydra is the sole responsibility of the user, and under no circumstances will the manufacturer be held liable for compensation or the recovery of this data.

2 System Setup

2.1 Hard Drive Assembly

The drives can be installed at any position, there is no specific order required. Be careful not to damage any components, and do not force the drives into place. If they don't slide in properly, make sure the drives have been installed correctly.

1. Unlock the switch at the bottom of the case, push the inner chassis from the back until the front panel is out of the housing, pull the front panel out and then lift it up to remove it. Turn the screws on the cassettes counter-clockwise to loosen and pull them out.

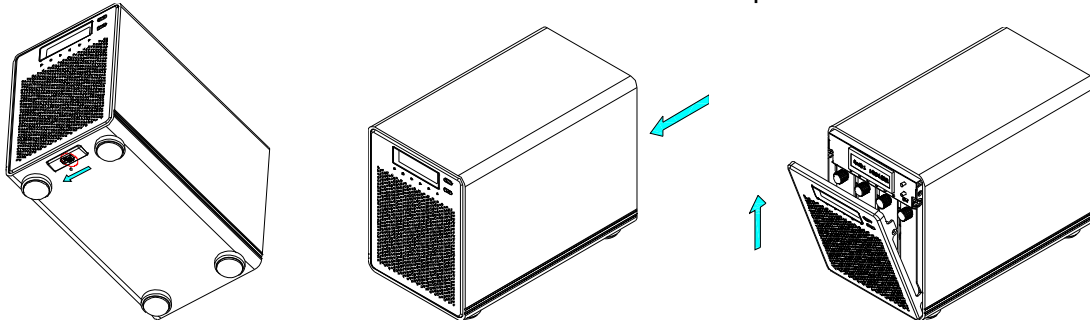

2. Install the hard drive as illustrated below with the SATA connector facing away from the front. Mount the drive with the six screws from the side.

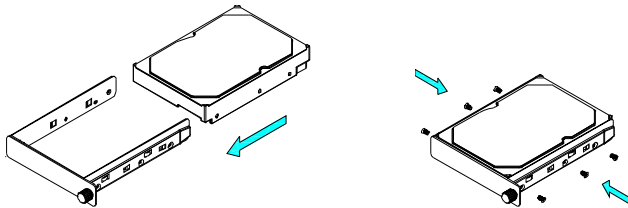

3. Slide the cassette back into the case, push it lightly into place and fasten the screw.
4. Repeat the previous steps for each hard drive cassette you are planning to install.
5. Replace the front panel, turn on the power, connect the drive to your computer, set your preferred RAID mode, create a new partition and format the drives.

Note

It is not possible to add more drives to an existing RAID array without re-formatting it. To add additional drives at a later point, install the drive(s), change the RAID mode or re-confirm the current mode and then create a new partition and format the drives again.

Important

Upon initial start up of the device and when changing the RAID mode, any existing data on the installed hard drives will be erased. Please make sure you backup all data prior to installing the hard drives and prior to changing the RAID mode!

2.2 Replacing Hard Drives

When one of the drives fails, the Rebuild LED will light up yellow and the corresponding HDD LED will light up red. If only one drive is defective and the RAID mode is set to RAID 1, RAID 3, RAID 5 or RAID 10, the data can still be accessed but we strongly recommend replacing the faulty drive immediately to assure continued backup and data safety.

If more than one drive at the same time fails or if the RAID mode is set to RAID 0 or Spanning, the data will be lost and the system can not be accessed again until the drive(s) have been replaced.

1. Check the HDD LED and replace the faulty drive. The red LED indicates the defective HDD. The power does not have to be turned off when replacing the drive(s).
2. A few seconds after installing the new drive(s) the corresponding LED will turn green.
3. For RAID 1, RAID 3, RAID 5 and RAID 10, the RAID array will be rebuilt automatically. During this process, the Rebuild LED will be flashing yellow. Rebuilding the RAID array will take several hours, depending on the drive capacity.
4. For RAID 0 and Spanning, erase the old partition, create a new one and then format the drives again.

Note

We recommend not turning off the power during the rebuild process but if it is interrupted, it will continue rebuilding the data as soon as the power is turned back on.

2.3 Connection to Computer

A few precautions and notes when using your external storage drive:

- Do not expose the product to water or humid conditions.
- Do not cover the enclosure's ventilation holes.
- Only one interface can be used at any given time.
- When more than one cable is connected, the eSATA connection has priority. To use a different interface, disconnect the other cables first, before connecting the new one.
- Before connecting the device, install the hard drives and set your preferred RAID mode.
- For the safe removal of your drive and to assure that no data is lost, always follow the correct unplug procedure for external hardware (e.g.: Eject the drive before removal).
- In order for the computer to access volumes larger than 2TB, both the hardware and Operating System need to support large volumes (e.g.: WinVista 32bit/64bit or Mac OS 10.4 and above) or the >2TB option should be disabled

3 LCD Display

The LCD display shows the system status, detailed information about the hard drives as well as the system configuration and provides the option to modify certain device settings.

To select a menu or change an option, use the [Select] button. To enter a menu and confirm a change, use the [OK] button. For further details, follow the on-screen wizard or refer to the following step by step descriptions.

3.1 Main Menu

Press the [Select] button to change between the different menus and press the [OK] button to enter a menu.

1. The main screen displays the product name and the current RAID mode.
2. The system information will show further details about the device configuration and the hardware.
3. The HDD information will show further details about the installed hard drives.
4. The settings menu offers options to change the device configuration.

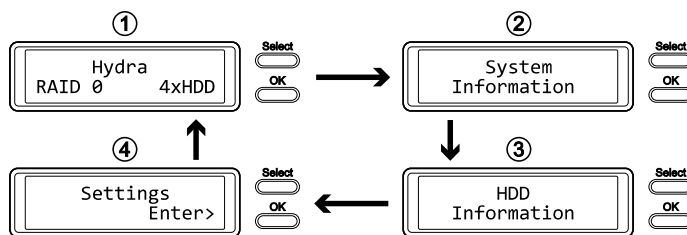

3.2 System Information

Press the [Select] button until the system information menu is selected and then press the [OK] button to start displaying further details about the device configuration and the hardware. It will automatically cycle through the different information displaying each screen for about 8 seconds and then return to the main screen. To fast forward, press the [Select] button.

1. The main screen of the system information menu.
2. The serial number is a combination of the 1394 vendor ID, the chip ID Hi and the chip ID Lo.
3. Displays the current firmware version of the Hydra Super-S LCM.
4. The I/O status shows the interface that is currently used for the connection to the computer.
5. Displays the current speed of the smart-fan and the temperature from its thermal probe.
6. Displays the current status of the >2TB and the alarm function.
7. Displays how the RAID mode is set (LCM = LCD display, AP = external program) and the total storage capacity.

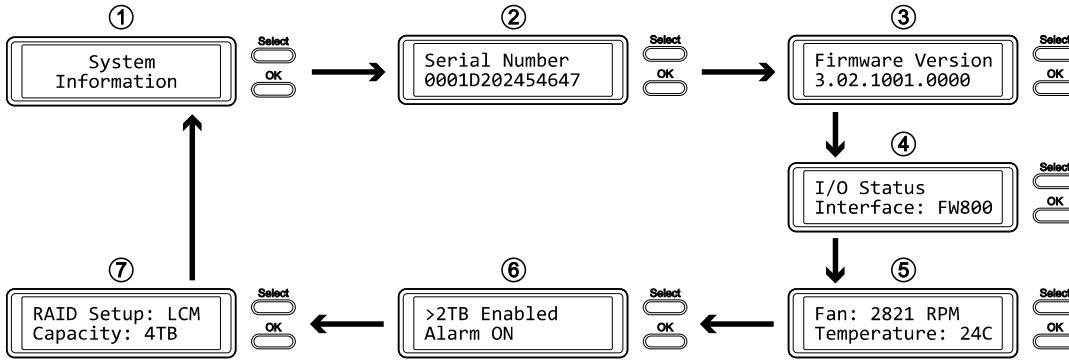

3.3 HDD Information

Press the [Select] button until the HDD information menu is selected and then press the [OK] button to start displaying further details about the installed hard drives. It will automatically cycle through the different information displaying each screen for about 8 seconds and then return to the main screen. To fast forward, press the [Select] button.

1. The main screen of the HDD information menu.
2. Displays the model number and serial number of the drive installed at HDD1.
3. Displays the total storage capacity and the temperature of the drive installed at HDD1.
4. The same information is also displayed for the drives installed at HDD2, HDD3 and HDD4.

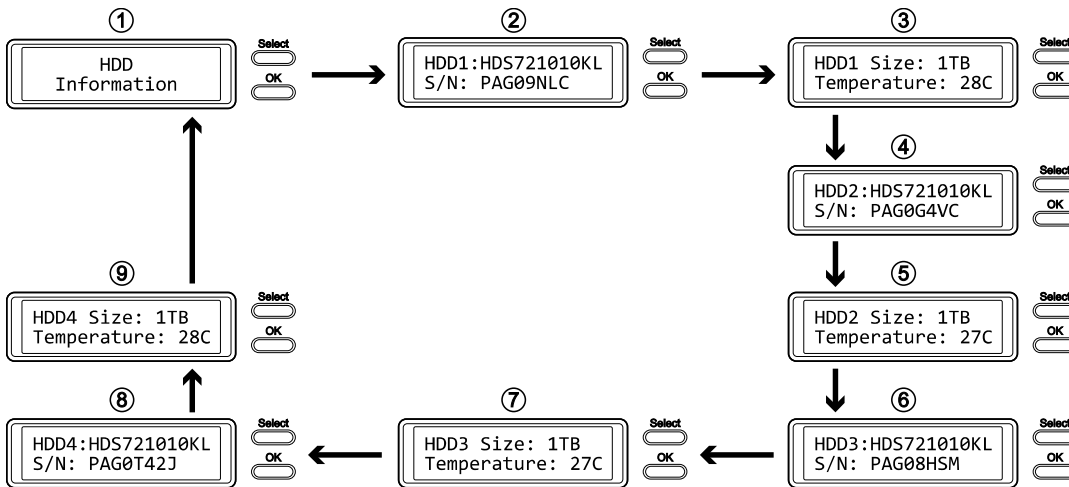

3.4 Settings

Press the [Select] button until the settings menu is selected and then press the [OK] button to enter the configuration menu. You can now use the [Select] button to cycle through the different settings and the [OK] button to further configure the device settings.

1. Option to enable or disable the support for large volumes in excess of 2TB.
2. Setup menu for the RAID settings.
3. Option to enable or disable the general alarm sound.
4. Option to enable or disable the temperature alarm sound.
5. Setup menu to define the fan speed of the smart fan.
6. Setup menu to define how long the backlight for the LCD display stays lit.
7. To exit the settings menu and return to the main menu.

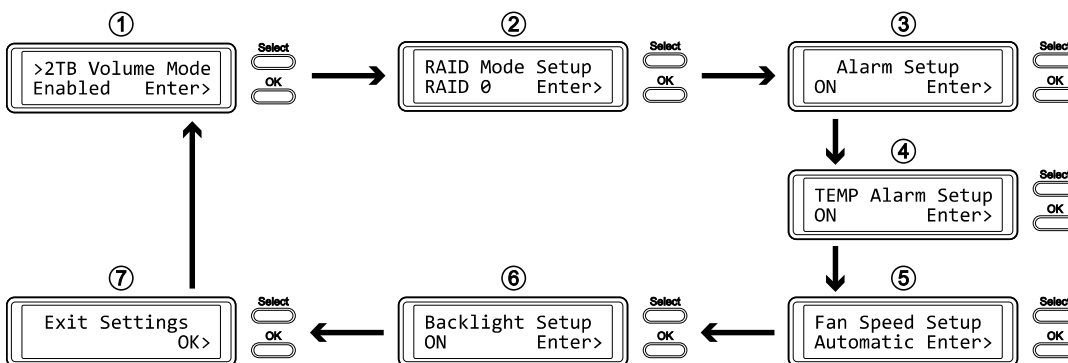

3.4.1 >2TB Volume Mode

In order for the computer to access volumes larger than 2TB, both the hardware and Operating System need to have the capacity to support large volumes (e.g.: WinVista 32bit/64bit or Mac OS 10.4 and above) or the >2TB option should be disabled.

- [Enabled] Supports volumes in excess of 2TB. If the total storage capacity exceeds 2TB, older Operating Systems will not be able to mount and access the drive.
- [Disabled] Only supports volumes up to 2TB. If the total storage capacity exceeds 2TB, the remaining storage space can not be accessed but on the other hand, older Operating Systems are still able to use the drive.

Press the [OK] button to enter the setup menu and press the [Select] button to cycle through the different options.

- To exit the menu without changing any of the settings, press the [Select] button until you see the Exit screen and then press the [OK] button.
- To change the setting, press the [Select] button to choose your preferred mode, press the [OK] button to select it and then press the [OK] button again to confirm the change.

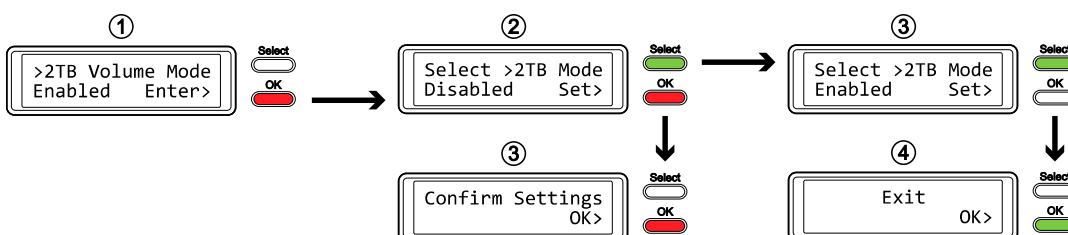

3.4.2 RAID Mode Setup

In order to set the RAID mode via LCD display, make sure the RAID SET switch behind the front panel is not in the locked position.

- [SPAN] Disk spanning.
- [RAID 0] Disk striping.
- [RAID 1/10] Disk mirroring (2xHDD → RAID 1, 4xHDD RAID 10).
- [RAID 3] Disk striping with dedicated parity. To use a spare drive, install 3 drives, turn on the device, set it to RAID 3, let it restart and then install the fourth drive.
- [RAID 5] Disk striping with distributed parity. To use a spare drive, install 3 drives, turn on the device, set it to RAID 5, let it restart and then install the fourth drive.

Press the [OK] button to enter the setup menu and press the [Select] button to cycle through the different options.

- To exit the menu without changing any of the settings, press the [Select] button until you see the Exit screen and then press the [OK] button.
- To change the setting, press the [Select] button to choose your preferred mode, press the [OK] button to select it, press the [OK] button again to confirm the change and once more to acknowledge that all data will be erased by this change. The device will restart automatically and after start up, one more confirmation is required to set the new RAID mode.

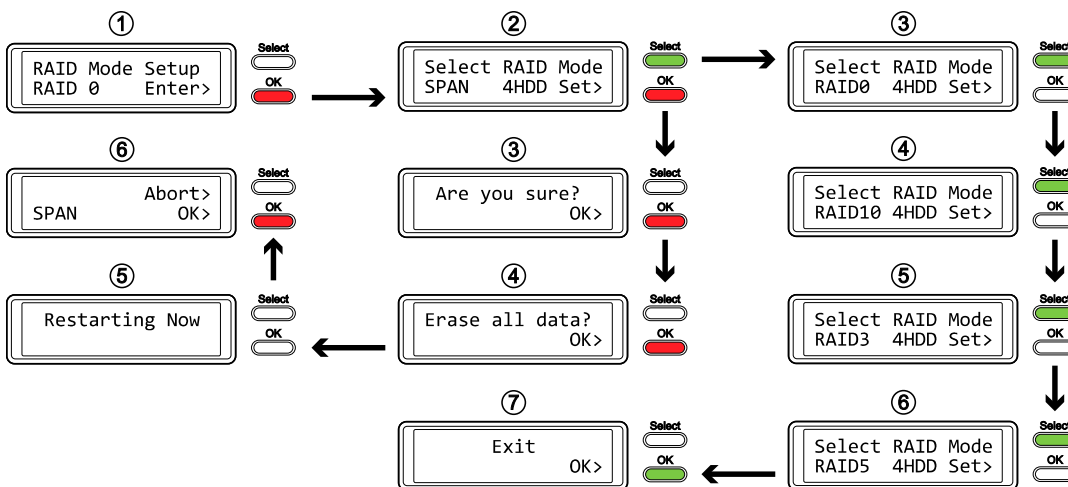

Note

Changing the RAID mode requires you to re-format the drives. This will erase all data on the hard drives that are being formatted. Make sure to backup all existing data first!

The amount of hard drives that are currently installed will be displayed right after the RAID mode (e.g. 4HDD). This information is for reference only and can not be selected or changed via LCD display, so the RAID array will be built with the current amount of drives.

3.4.3 Alarm Setup

The general alarm sound is the short beep you hear when starting up the system and it will sound when something is wrong. To enable or disable the alarm, do one of the following.

- [ON] Beeper and alarm is enabled.
- [OFF] Beeper and alarm is disabled.

Press the [OK] button to enter the setup menu and press the [Select] button to cycle through the different options.

- To exit the menu without changing any of the settings, press the [Select] button until you see the Exit screen and then press the [OK] button.
- To change the setting, press the [Select] button to choose your preferred mode and then press the [OK] button to confirm the change.

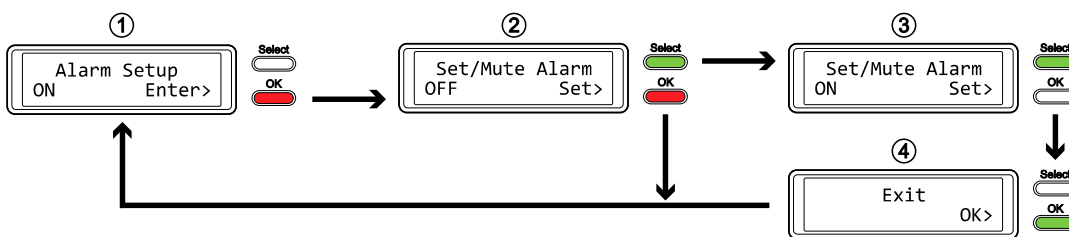

3.4.4 TEMP Alarm Setup

This is the alarm sound you hear when the internal temperature that is measured by the thermal probe reaches a critical level (>61°C). You can enable or disable it here.

- [ON] High temperature alarm is enabled.
- [OFF] High temperature alarm is disabled.

Press the [OK] button to enter the setup menu and press the [Select] button to cycle through the different options.

- To exit the menu without changing any of the settings, press the [Select] button until you see the Exit screen and then press the [OK] button.
- To change the setting, press the [Select] button to choose your preferred mode and then press the [OK] button to confirm the change.

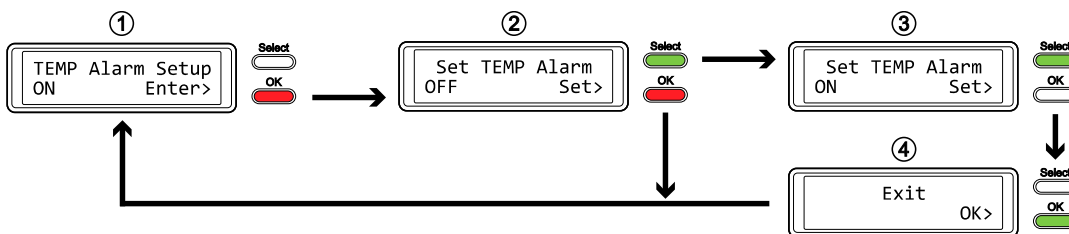

3.4.5 Fan Speed Setup

The smart-fan can automatically regulate the fan speed according to the internal case temperature, it can be set at a certain speed or it can be deactivated.

- [Automatic] Regulates the fan speed according to the HDD temperature (below 45°C = low speed, 45-60°C = speed increases in 5 steps, above 61°C = high speed).
- [HighSpeed] Fan speed is set to high speed.
- [LowSpeed] Fan speed is set to low speed.
- [OFF] The fan is turned off. This setting should only be used if the device is located in a cool and temperature controlled room.

Press the [OK] button to enter the setup menu and press the [Select] button to cycle through the different options.

- To exit the menu without changing any of the settings, press the [Select] button until you see the Exit screen and then press the [OK] button.
- To change the setting, press the [Select] button to choose your preferred mode and then press the [OK] button to confirm the change.

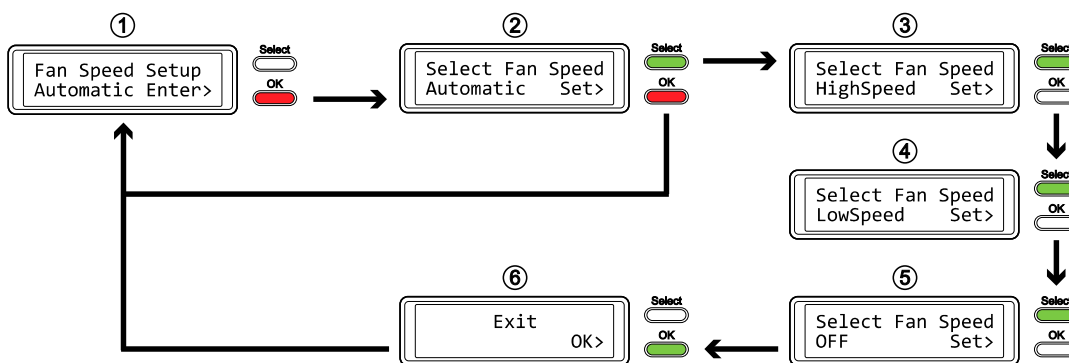

3.4.6 Backlight Setup

The backlight for the LCD display can be enabled, disabled or set so that it turns off automatically, when the screen has been idle for a certain amount of time.

- [ON] Always ON.
- [OFF] Always OFF.
- [1min] Backlight turns off when the screen has been idle for more than one minute.
- [3min] Backlight turns off when the screen has been idle for more than three minutes.
- [5min] Backlight turns off when the screen has been idle for more than five minutes.

Press the [OK] button to enter the setup menu and press the [Select] button to cycle through the different options.

- To exit the menu without changing any of the settings, press the [Select] button until you see the Exit screen and then press the [OK] button.
- To change the setting, press the [Select] button to choose your preferred mode and then press the [OK] button to confirm the change.

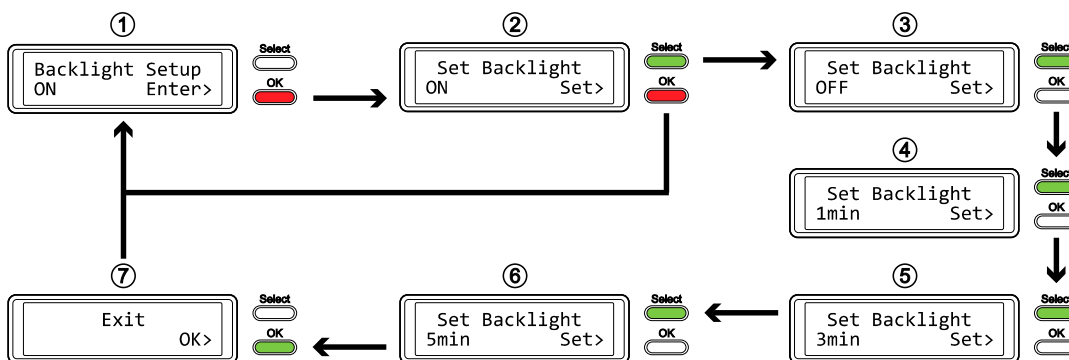

3.5 Event Information

In addition to the details about the hardware and device configuration, the LCD display will also show certain event information. Following is a list of possible messages and their meanings.

- **[HDD Error / Remaining 3xHDD]**
When using RAID 0 or SPAN and one of the drives fails, the alarm will go off and the display indicates the amount of the remaining drives that are still working OK. Refer to the HDD LED's in order to locate the defective drive.
- **[RAID Warning / Degraded Array]**
When using RAID 1, 10, 3 or 5 and one of the drives fails, the alarm will go off and the display shows this message. Press the [OK] button to temporarily mute the alarm and use the HDD LED's in order to locate the defective drive.
- **[XX Cable / Connected]**
Shows which cable has been connected.
- **[Cable / Disconnected]**
Shows when the cable has been unplugged.
- **[Rebuilding... / Hrs left xhxxmin]**
Shows during the rebuild process of a RAID array with an approximate time in hours and minutes indicating how long it takes until the backup is done.
- **[Alarm / High Temperature]**
Indicates critical temperature (>61°C).
- **[Alarm / Fan Failure]**
Indicates a fan failure or unexpectedly slow RPM.
- **[Detecting Disk / Starting...]**
Shows during start up of the system.
- **[XX / Starting ...]**
Shows during start up of the system.
- **[RAID Mode Locked]**
Shows when trying to change the RAID mode via LCD display but the RAID SET switch is set to lock the settings.

4 Appendix

4.1 Safety Information

4.1.1 6-pin FireWire cable

When using a 6-pin FireWire cable, make sure NOT to insert the connector the wrong way (upside down), or you will damage the device!

4.1.2 Location and placing precautions

Do not cover the device and do not place the unit on other heat-sensitive equipment. Avoid positioning it in the following places:

- Locations with direct sunlight, next to radiators or other sources of heat with high temperatures (more than 35° C) or high humidity (more than 90%).
- Locations subject to vibration, shock, or with a slope.
- Do not expose the product to water or humid conditions.

4.1.3 Electricity and power plug

Careful attention must be paid to the following points in order to avoid electric shock or fire:

- Always connect the power cord to your device before you plug it into the wall socket.
- Do not touch the power cable with wet hands and never try to modify the power cable.
- If the unit should emit smoke, an unusual odour or noise, switch it off immediately.
- Use only the cables supplied or recommended by your vendor in order to avoid malfunction.

4.2 FAQ

Q: What file system should I choose to format my drive?

A: This will depend on how you want to use the drive but in general, we recommend:

- Windows XP/Vista → NTFS
- Mac OS X → HFS+ (Mac OS Extended)
- To use it on both PC and Mac → FAT32 (single files size is limited to 4GB)

Q: How many drives can fail before I loose my data?

A: This depends on the RAID mode. For RAID 0 and Spanning, any drive failure will result in the data being lost. For RAID 1, RAID 3, RAID 5 and RAID 10, more than one drive failure at the same time will mean the data can not be recovered anymore.

Q: Will the hard drives spin down when my computer goes into stand-by mode?

A: No, to provide immediate access to your data, the drives will always keep spinning as long as the power is turned on.

Q: Why does the LED indication for some of the drives light up red?

A: If one of the HDD LEDs lights up red and at the same time the Rebuild LED lights up yellow, the drive is defective. If less than 4 drives are installed and the Rebuild LED does not light up at the same time, it simply indicates that there is no drive in that bay.

© Copyright 2009 by Macpower & Tytech Technology Co., Ltd. all Rights Reserved

The information contained in this manual is believed to be accurate and reliable. Macpower & Tytech Technology assumes no responsibility for any errors contained in this manual. Macpower & Tytech Technology reserves the right to make changes in the specifications and/or design of this product without prior notice. The diagrams contained in this manual may also not fully represent the product that you are using and are there for illustration purposes only. Macpower & Tytech Technology assumes no responsibility for any differences between the product mentioned in this manual and the product you may have.